

INNERSHIELD®

ELECTRODES

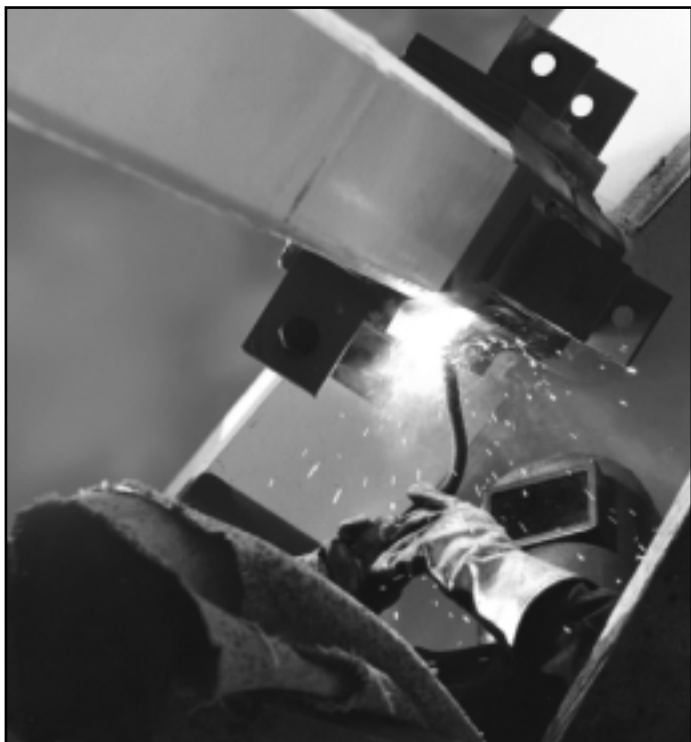

Welding Guide

LINCOLN®
ELECTRIC
THE WELDING EXPERTS

TABLE OF CONTENTS

SAFETY PRECAUTIONS	3-11
INTRODUCTION	12
PRODUCT ADVANTAGES	13-15
RECOMMENDED EQUIPMENT	15
WELDING PREPARATIONS	16-17
Choose the Proper Innershield Gun	16
Prepare the Work	17
Optimizing Feeding	17
WELDING TECHNIQUES	18-24
Set the CTWD	18
Set the Wire Feed Speed (WFS)	19
Start the Arc	19
Set the Voltage	19
Travel Speed	19
Loading 13-14 Lb. Coils on a 2" Spindle	20
Handling Poor Fitup	21
Use the Proper Drag Angle	21
Use the Proper Wire Angle to Joint	21
Making Vertical Up Welds	22-23
Making Downhill and Vertical Down Welds	23
Working with NS-3M	24
OPERATING GUIDE	25-29
Troubleshooting	25-26
Effect of Operating Variables	26-27
Welder Qualification Test	27
Storing Innershield Electrode	28-29
WELDING PROCEDURES	30-39
OPERATING PROCEDURES	40-45
INNERSHIELD GUN PARTS	46-47
LINCOLN WELDING SCHOOL	48-49

The serviceability of a product or structure utilizing this type of information is and must be the sole responsibility of the builder/user. Many variables beyond the control of The Lincoln Electric Company affect the results obtained in applying this type of information. These variables include, but are not limited to, welding procedure, plate chemistry and temperature, weldment design, fabrication methods and service requirements.

-SAFETY-



WARNING

CALIFORNIA PROPOSITION 65 WARNINGS

Diesel engine exhaust and some of its constituents are known to the State of California to cause cancer, birth defects, and other reproductive harm.

The Above For Diesel Engines

The engine exhaust from this product contains chemicals known to the State of California to cause cancer, birth defects, or other reproductive harm.

The Above For Gasoline Engines

ARC WELDING CAN BE HAZARDOUS. PROTECT YOURSELF AND OTHERS FROM POSSIBLE SERIOUS INJURY OR DEATH. KEEP CHILDREN AWAY. PACEMAKER WEARERS SHOULD CONSULT WITH THEIR DOCTOR BEFORE OPERATING.

Read and understand the following safety highlights. For additional safety information, it is strongly recommended that you purchase a copy of "Safety in Welding & Cutting - ANSI Standard Z49.1" from the American Welding Society, P.O. Box 351040, Miami, Florida 33135 or CSA Standard W117.2-1974. A Free copy of "Arc Welding Safety" booklet E205 is available from the Lincoln Electric Company, 22801 St. Clair Avenue, Cleveland, Ohio 44117-1199.

BE SURE THAT ALL INSTALLATION, OPERATION, MAINTENANCE AND REPAIR PROCEDURES ARE PERFORMED ONLY BY QUALIFIED INDIVIDUALS.

Mar '95



FOR ENGINE powered equipment.

1.a. Turn the engine off before troubleshooting and maintenance work unless the maintenance work requires it to be running.

1.b. Operate engines in open, well-ventilated areas or vent the engine exhaust fumes outdoors.



1.c. Do not add the fuel near an open flame welding arc or when the engine is running. Stop the engine and allow it to cool before refueling to prevent spilled fuel from vaporizing on contact with hot engine parts and igniting. Do not spill fuel when filling tank. If fuel is spilled, wipe it up and do not start engine until fumes have been eliminated.



1.d. Keep all equipment safety guards, covers and devices in position and in good repair. Keep hands, hair, clothing and tools away from V-belts, gears, fans and all other moving parts when starting, operating or repairing equipment.

1.e. In some cases it may be necessary to remove safety guards to perform required maintenance. Remove guards only when necessary and replace them when the maintenance requiring their removal is complete. Always use the greatest care when working near moving parts.

1.f. Do not put your hands near the engine fan. Do not attempt to override the governor or idler by pushing on the throttle control rods while the engine is running.



1.g. To prevent accidentally starting gasoline engines while turning the engine or welding generator during maintenance work, disconnect the spark plug wires, distributor cap or magneto wire as appropriate.



1.h. To avoid scalding, do not remove the radiator pressure cap when the engine is hot.



ELECTRIC AND MAGNETIC FIELDS may be dangerous

- 2.a. Electric current flowing through any conductor causes localized Electric and Magnetic Fields (EMF). Welding current creates EMF fields around welding cables and welding machines
- 2.b. EMF fields may interfere with some pacemakers, and welders having a pacemaker should consult their physician before welding.
- 2.c. Exposure to EMF fields in welding may have other health effects which are now not known.
- 2.d. All welders should use the following procedures in order to minimize exposure to EMF fields from the welding circuit:
 - 2.d.1. Route the electrode and work cables together - Secure them with tape when possible.
 - 2.d.2. Never coil the electrode lead around your body.
 - 2.d.3. Do not place your body between the electrode and work cables. If the electrode cable is on your right side, the work cable should also be on your right side.
 - 2.d.4. Connect the work cable to the workpiece as close as possible to the area being welded.
 - 2.d.5. Do not work next to welding power source.



ELECTRIC SHOCK can kill.

- 3.a. The electrode and work (or ground) circuits are electrically “hot” when the welder is on. Do not touch these “hot” parts with your bare skin or wet clothing. Wear dry, hole-free gloves to insulate hands.
- 3.b. Insulate yourself from work and ground using dry insulation. Make certain the insulation is large enough to cover your full area of physical contact with work and ground.

In addition to the normal safety precautions, if welding must be performed under electrically hazardous conditions (in damp locations or while wearing wet clothing; on metal structures such as floors, gratings or scaffolds; when in cramped positions such as sitting,

(Cont'd on page 5)

ELECTRIC SHOCK can kill. (Cont'd)

kneeling or lying, if there is a high risk of unavoidable or accidental contact with the workpiece or ground) use the following equipment:

- **Semiautomatic DC Constant Voltage (Wire) Welder.**
- **DC Manual (Stick) Welder.**
- **AC Welder with Reduced Voltage Control.**

- 3.c. In semiautomatic or automatic wire welding, the electrode, electrode reel, welding head, nozzle or semiautomatic welding gun are also electrically “hot”.
- 3.d. Always be sure the work cable makes a good electrical connection with the metal being welded. The connection should be as close as possible to the area being welded.
- 3.e. Ground the work or metal to be welded to a good electrical (earth) ground.
- 3.f. Maintain the electrode holder, work clamp, welding cable and welding machine in good, safe operating condition. Replace damaged insulation.
- 3.g. Never dip the electrode in water for cooling.
- 3.h. Never simultaneously touch electrically “hot” parts of electrode holders connected to two welders because voltage between the two can be the total of the open circuit voltage of both welders.
- 3.i. When working above floor level, use a safety belt to protect yourself from a fall should you get a shock.
- 3.j. Also see Items 6.c. and 8.

ARC RAYS can burn.



- 4.a. Use a shield with the proper filter and cover plates to protect your eyes from sparks and the rays of the arc when welding or observing open arc welding. Headshield and filter lens should conform to ANSI Z87.1 standards.
- 4.b. Use suitable clothing made from durable flame-resistant material to protect your skin and that of your helpers from the arc rays.
- 4.c. Protect other nearby personnel with suitable, non-flammable screening and/or warn them not to watch the arc nor expose themselves to the arc rays or to hot spatter or metal.



FUMES AND GASES can be dangerous.

- 5.a. Welding may produce fumes and gases hazardous to health. Avoid breathing these fumes and gases. When welding, keep your head out of the fume. Use enough ventilation and/or exhaust at the arc to keep fumes and gases away from the breathing zone. **When welding with electrodes which require special ventilation such as stainless or hard facing (see instructions on container or MSDS) or on lead or cadmium plated steel and other metals or coatings which produce highly toxic fumes, keep exposure as low as possible and below Threshold Limit Values (TLV) using local exhaust or mechanical ventilation. In confined spaces or in some circumstances, outdoors, a respirator may be required. Additional precautions are also required when welding on galvanized steel.**
- 5.b. Do not weld in locations near chlorinated hydrocarbon vapors coming from degreasing, cleaning or spraying operations. The heat and rays of the arc can react with solvent vapors to form phosgene, a highly toxic gas, and other irritating products.
- 5.c. Shielding gases used for arc welding can displace air and cause injury or death. Always use enough ventilation, especially in confined areas, to insure breathing air is safe.
- 5.d. Read and understand the manufacturer's instructions for this equipment and the consumables to be used, including the material safety data sheet (MSDS) and follow your employer's safety practices. MSDS forms are available from your welding distributor or from the manufacturer.
- 5.e. Also see item 1.b.

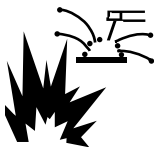

WELDING SPARKS can cause fire or explosion.

- 6.a. Remove fire hazards from the welding area. If this is not possible, cover them to prevent the welding sparks from starting a fire. Remember that welding sparks and hot materials from welding can easily go through small cracks and openings to adjacent areas. Avoid welding near hydraulic lines. Have a fire extinguisher readily available.
- 6.b. Where compressed gases are to be used at the job site, special precautions should be used to prevent hazardous situations. Refer to "Safety in Welding and Cutting" (ANSI Standard Z49.1) and the operating information for the equipment being used.

WELDING SPARKS can cause fire or explosion.

(Cont'd)

- 6.c. When not welding, make certain no part of the electrode circuit is touching the work or ground. Accidental contact can cause overheating and create a fire hazard.
- 6.d. Do not heat, cut or weld tanks, drums or containers until the proper steps have been taken to insure that such procedures will not cause flammable or toxic vapors from substances inside. They can cause an explosion even though they have been "cleaned". For information, purchase "Recommended Safe Practices for the Preparation for Welding and Cutting of Containers and Piping That Have Held Hazardous Substances", AWS F4.1 from the American Welding Society (see address above).
- 6.e. Vent hollow castings or containers before heating, cutting or welding. They may explode.
- 6.f. Sparks and spatter are thrown from the welding arc. Wear oil free protective garments such as leather gloves, heavy shirt, cuffless trousers, high shoes and a cap over your hair. Wear ear plugs when welding out of position or in confined places. Always wear safety glasses with side shields when in a welding area.
- 6.g. Connect the work cable to the work as close to the welding area as practical. Work cables connected to the building framework or other locations away from the welding area increase the possibility of the welding current passing through lifting chains, crane cables or other alternate circuits. This can create fire hazards or overheat lifting chains or cables until they fail.
- 6.h. Also see item 1.c.

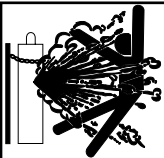

CYLINDER may explode if damaged.

- 7.a. Use only compressed gas cylinders containing the correct shielding gas for the process used and properly operating regulators designed for the gas and pressure used. All hoses, fittings, etc. should be suitable for the application and maintained in good condition.
- 7.b. Always keep cylinders in an upright position securely chained to an undercarriage or fixed support.
- 7.c. Cylinders should be located:
 - Away from areas where they may be struck or subjected to physical damage.
 - A safe distance from arc welding or cutting operations and any other source of heat, sparks, or flame.

CYLINDER may explode if damaged.

(Cont'd)

- 7.d. Never allow the electrode, electrode holder or any other electrically "hot" parts to touch a cylinder.
- 7.e. Keep your head and face away from the cylinder valve outlet when opening the cylinder valve.
- 7.f. Valve protection caps should always be in place and hand tight except when the cylinder is in use or connected for use.
- 7.g. Read and follow the instructions on compressed gas cylinders, associated equipment, and CGA publication P-1, "Precautions for Safe Handling of Compressed Gases in Cylinders," available from the Compressed Gas Association 1235 Jefferson Davis Highway, Arlington, VA 22202.



FOR ELECTRICALLY powered equipment.

- 8.a. Turn off input power using the disconnect switch at the fuse box before working on the equipment.
- 8.b. Install equipment in accordance with the U.S. National Electrical Code, all local codes and the manufacturer's recommendations.
- 8.c. Ground the equipment in accordance with the U.S. National Electrical Code and the manufacturer's recommendations.

PRÉCAUTIONS DE SÛRETÉ

Pour votre propre protection lire et observer toutes les instructions et les précautions de sûreté spécifiques qui paraissent dans ce manuel aussi bien que les précautions de sûreté générales suivantes:

Sûreté Pour Soudage A L'Arc

- 1. Protégez-vous contre la secousse électrique:
 - a. Les circuits à l'électrode et à la pièce sont sous tension quand la machine à souder est en marche. Eviter toujours tout contact entre les parties sous tension et la peau nue ou les vêtements mouillés. Porter des gants secs et sans trous pour isoler les mains.

- b. Faire très attention de bien s'isoler de la masse quand on soude dans des endroits humides, ou sur un plancher métallique ou des grilles métalliques, principalement dans les positions assis ou couché pour lesquelles une grande partie du corps peut être en contact avec la masse.
 - c. Maintenir le porte-électrode, la pince de masse, le câble de soudage et la machine à souder en bon et sûr état de fonctionnement.
 - d. Ne jamais plonger le porte-électrode dans l'eau pour le refroidir.
 - e. Ne jamais toucher simultanément les parties sous tension des porte-électrodes connectés à deux machines à souder parce que la tension entre les deux pinces peut être le total de la tension à vide des deux machines.
 - f. Si on utilise la machine à souder comme une source de courant pour soudage semi-automatique, ces précautions pour le porte-électrode s'appliquent aussi au pistolet de soudage.
2. Dans le cas de travail au dessus du niveau du sol, se protéger contre les chutes dans le cas où on reçoit un choc. Ne jamais enrouler le câble-électrode autour de n'importe quelle partie du corps.
3. Un coup d'arc peut être plus sévère qu'un coup de soleil, donc:
 - a. Utiliser un bon masque avec un verre filtrant approprié ainsi qu'un verre blanc afin de se protéger les yeux du rayonnement de l'arc et des projections quand on soude ou quand on regarde l'arc.
 - b. Porter des vêtements convenables afin de protéger la peau de soudeur et des aides contre le rayonnement de l'arc.
 - c. Protéger l'autre personnel travaillant à proximité au soudage à l'aide d'écrans appropriés et non-inflammables.
4. Des gouttes de laitier en fusion sont émises de l'arc de soudage. Se protéger avec des vêtements de protection libres de l'huile, tels que les gants en cuir, chemise épaisse, pantalons sans revers, et chaussures montantes.
5. Toujours porter des lunettes de sécurité dans la zone de soudage. Utiliser des lunettes avec écrans latéraux dans les zones où l'on pique le laitier.
6. Eloigner les matériaux inflammables ou les recouvrir afin de prévenir tout risque d'incendie dû aux étincelles.

7. Quand on ne soude pas, poser la pince à un endroit isolé de la masse. Un court-circuit accidentel peut provoquer un échauffement et un risque d'incendie.
8. S'assurer que la masse est connectée le plus près possible de la zone de travail qu'il est pratique de le faire. Si on place la masse sur la charpente de la construction ou d'autres endroits éloignés de la zone de travail, on augmente le risque de voir passer le courant de soudage par les chaînes de levage, câbles de grue, ou autres circuits. Cela peut provoquer des risques d'incendie ou d'échauffement des chaînes et des câbles jusqu'à ce qu'ils se rompent.
9. Assurer une ventilation suffisante dans la zone de soudage. Ceci est particulièrement important pour le soudage de tôles galvanisées plombées, ou cadmiées ou tout autre métal qui produit des fumées toxiques.
10. Ne pas souder en présence de vapeurs de chlore provenant d'opérations de dégraissage, nettoyage ou pistolage. La chaleur ou les rayons de l'arc peuvent réagir avec les vapeurs du solvant pour produire du phosgène (gaz fortement toxique) ou autres produits irritants.
11. Pour obtenir de plus amples renseignements sur la sûreté, voir le code "Code for safety in welding and cutting" CSA Standard W 117.2-1974.

PRÉCAUTIONS DE SÛRETÉ POUR LES MACHINES À SOUDER À TRANSFORMATEUR ET À REDRESSEUR

1. Relier à la terre le châssis du poste conformément au code de l'électricité et aux recommandations du fabricant. Le dispositif de montage ou la pièce à souder doit être branché à une bonne mise à la terre.
2. Autant que possible, l'installation et l'entretien du poste seront effectués par un électricien qualifié.
3. Avant de faire des travaux à l'intérieur de poste, la débrancher à l'interrupteur à la boîte de fusibles.
4. Garder tous les couvercles et dispositifs de sûreté à leur place.

INTRODUCTION

INNERSHIELD®

Innershield is an arc welding process that uses a continuously fed wire to supply filler metal to the arc. The wire is not solid, but is tubular. Agents necessary to shield the arc from the surrounding atmosphere are placed inside the tube. No additional shielding is required. Innershield was originally used as a replacement for stick welding. Innershield can provide higher productivity and enhance quality when compared to stick welding. It offers increased arc-on time due to the continuous nature of the process. There are also fewer starts and stops, which are frequent sources for defects.

Although the Innershield process has been displaced in many areas by gas-shielded processes, Innershield continues to be an important process for steel fabrication in many markets. Innershield is the primary means for structural steel building erection in the United States. In any shop or shipyard where wind is a problem, Innershield can be a viable solution. Pipeline fabrication is often done with Innershield because it is done outdoors and shielding gas is sometimes difficult to get to these locations.

Lincoln Electric, the originator of the Innershield process, makes Innershield wire in a proprietary manner. The manufacturing processes that Lincoln Electric uses has specific benefits that you can see in every pound of wire you use. The Innershield wires Lincoln Electric produces are very stiff and have excellent column strength. This allows for excellent feedability. Lincoln Electric also fills the wire in a proprietary manner. This step ensures that you get the right amount of fill in every inch of wire. Lincoln Electric is the worldwide leader in Innershield. You can see that when you use our products, meet with our sales reps, or call the factory for support.

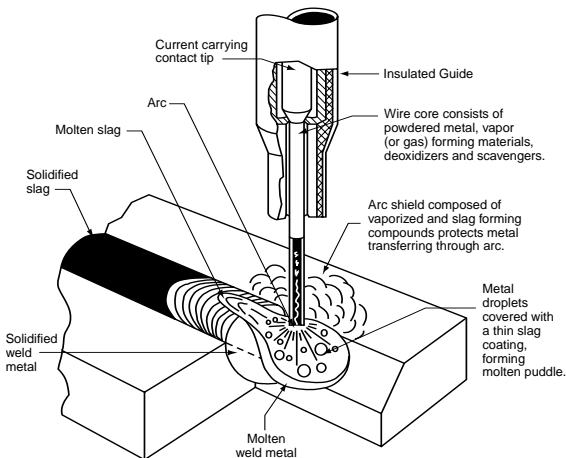

PRODUCT ADVANTAGES

INNERSHIELD FEATURES

- Can be used in wind speeds of up to 30 mph without losing mechanical properties.
- Gas bottles are unnecessary.
- Stiff wire with high column strength.

BENEFITS OVER GAS-SHIELDED PROCESSES

- Innershield does not require gas shielding.
 - No external shielding eliminates gas cost.
 - No shielding gas means no cylinder handling, changeout, and rental saving time and money.
 - No shielding gas means simpler guns and feeders for lower maintenance costs.
 - No shielding gas means no tenting to keep wind away saving labor costs.
- Innershield Wires are stiff.
 - Stiff wire is excellent for feedability.
 - Stiff wire allows for longer guns to be used, saving labor costs moving feeders and welders.
 - Stiff wire allows the welder to break off the wire without clippers.

BENEFITS OVER STICK WELDING

- Innershield is a continuous process.
 - This means less starts and stops, saving money and increasing quality.
 - This allows the welder to spend more time welding, not changing rods, decreasing labor costs.
- Innershield has higher deposition efficiency.
- Innershield does not produce “stubs” like the stick process. Stubs are materials you purchase and then throw away.

PRODUCT LIMITATIONS

SEISMIC APPLICATIONS:

Constant voltage (CV) power sources are recommended for use with all Innershield electrodes.

NR-211-MP THICKNESS RESTRICTIONS:

<u>Wire Diameter</u>	<u>Max. Plate Thickness</u>
.035", .045" (0.9, 1.2mm)	5/16" (7.9mm)
.068", 5/64", 3/32" (1.7, 2.0, 2.4mm)	1/2" (12.7mm)

NR-212 is designed to be used on plate up to 3/4" (19.1mm) thick.

SINGLE PASS LIMITATIONS

Certain FCAW-S electrodes are limited to single pass applications. These include, but are not limited to NR-1, NR-5, NR-131 and NR-152.

APPLICATION INFORMATION

SEISMIC STRUCTURAL WELDING APPLICATIONS

The electrodes below have been tested in accordance with FEMA 353 - *Recommended Specifications and Quality Assurance Guidelines for Steel Moment-Frame Construction for Seismic Applications*. FEMA 353 test certificates are available upon request. These certificates contain mechanical test results at low and high heat input levels and diffusible hydrogen classifications. The electrodes indicated with a * also have electrode exposure time on the certificate.

Electrode	Diameters
NR-203-MP	.068", 5/64"
NR-203 Nickel (1%)	5/64", 3/32"
NR-232*	.068", .072", 5/64"
NR-305*	3/32"
NR-311Ni	5/64", 3/32", 7/64"

ELECTRODE EXPOSURE

FEMA 353 and other specifications which limit electrode exposure may require monitoring electrode exposure time and/or conditions after removal from a sealed package.

PRODUCT LIMITATIONS

INTERMIXING

When Innershield (FCAW-S) weld deposits are intermixed with weld deposits from other welding processes, a decrease in weld metal Charpy V-notch (CVN) toughness properties may occur. For applications requiring CVN properties, intermix testing with the specific electrodes is recommended to ensure the intermixed weld metal meets the required CVN requirements.

TACK WELDING

The following electrodes are recommended for tack welding prior to Innershield welding:

- All Innershield (FCAW-S) wires
- SMAW: Fleetweld 35LS, Jetweld LH70, Jetweld 2, Excalibur 7018
- GMAW solid electrodes

AGING:

The AWS filler metal specification for these products (A5.20 & A5.29) permit aging of test specimens. When conducting welding procedure or operator qualification tests, it is recommended that aging be applied, whenever permitted by the appropriate code. For example, when qualifying procedures to AWS D1.1 Structural Welding Code, see Paragraph 5.10.4.

Preheat and interpass temperature control are recommended for optimum mechanical properties, crack resistance and hardness control. This is particularly important on multiple pass welds and heavier plate. Job conditions, prevailing codes, high restraint, alloy level and other considerations may also require preheat and interpass temperature control.

ARC GOUGING

When Arc Gouging Innershield welds, black smudges or spots may appear on the surface of the groove. The condition is aggravated when the carbon is allowed to touch the surface. This black residue does not indicate the presence of porosity or poor weld quality. It can be easily removed by wire brushing or light grinding.

INNERSHIELD GUNS

CHOOSE THE PROPER INNERSHIELD GUN

Lincoln Innershield Guns

Rated Amperage, Duty Cycle and Wire Sizes

Innershield Guns



K115-1, -2, -3, -4, -5 Guns with 82° Nozzle 450 Amps at 60% Duty Cycle
Wire Size: .068–.120"(1.7-3.0mm)



K115-8, -10 Guns with 45° Nozzle 450 Amps at 60% Duty Cycle
Wire Size: .068–.120"(1.7-3.0mm)



K116 -2 Gun 600 Amps at 60% Duty Cycle
Wire Size .120–7/64"(3.0-2.8mm)



K126-1, -2 Gun with 62° Nozzle 350 Amps at 60% Duty Cycle
Wire Size: .062–3/32"(1.6-2.4mm)



K361-10 Gun 350 Amps at 60% Duty Cycle
Wire Size .068–5/64"(1.7-2.0mm)

Fume Extraction Gun



K289-1, -4 500 Amps at 60% Duty Cycle
Wire Size: .120–7/64"(3.0-5.6mm)

Fume Extraction Guns



K206 Gun 350 Amps at 60% Duty Cycle
Wire Size: .062–3/32"(1.6-2.4mm)



K309 Gun 250 Amps at 60% Duty Cycle
Wire Size:.062–3/32"(1.6-2.4mm)

LN-23P Guns



K264-8 Gun with 30° Long Tube for LN-23P
250 Amps at 60% Duty Cycle
Wire Size: .068–5/64"(1.7-2.0mm)



K345 -10 Gun with 90° Standard Tube for LN-23P
350 Amps at 60% Duty Cycle
Wire Size: .068–5/64"(1.7-2.0mm)



K355-10 Gun with 90° Tube for LN-23P 250 Amps at 60% Duty Cycle
Wire Size: .068–5/64"(1.7-2.0mm)

For proper CTWD use the appropriate insulated guide. For specific information on wire size and cable length, please see your local Lincoln representative.

WELDING PREPARATIONS

PREPARE THE WORK

Clean the joint by removing excessive scale, rust, moisture, paint, oil and grease from the surface. As with all welding applications, joint cleanliness is necessary to avoid porosity and to attain the travel speeds indicated in the procedures.

Tack weld with Innershield wire or Fleetweld® 35LS, Jetweld® LH-70 or Jetweld 2 manual stick electrodes. If other electrodes are used, Innershield slag removal may be difficult in the area of the tacks.

The work connection can be placed either at the beginning or at the end of the weld, depending upon the application. If necessary, try different locations until the best weld quality is obtained.

Clamp the work cable to the work so there is a positive and clean metal-to-metal contact point. Poor work connections raise system voltage losses and can result in convex or ropey beads typical of low voltage, even if the machine meters indicate proper voltage.

Never use undersize or badly worn work cables. Choose the cable size per the following table:

Current Amps 60% Duty Cycle	Total Work and Electrode Cable Length ⁽¹⁾	
	0-50 ft. (0-15m)	50-100 ft. (15-30m)
300	1 (50mm ²)	1 (50mm ²)
400	2/0 (70mm ²)	2/0 (70mm ²)
500	2/0 (70mm ²)	2/0 (70mm ²)
600	3/0 (95mm ²)	3/0 (95mm ²)

⁽¹⁾ mm² equivalent according to IEC (International Electrical Code).

OPTIMIZING FEEDING

Most feeding problems are caused by improper handling of the gun cable or wire.

1. Do not kink or pull the cable around sharp corners. Keep the gun cable as straight as possible when welding.
2. Do not allow two-wheelers, fork lift trucks, etc. to run over the cables.
3. Keep the cable clean per instructions in the wire feeder operating manual.
4. Innershield wire has proper surface lubrication on it. Use only clean, rust-free wire.
5. Replace the nozzle contact tip when it becomes worn or the end appears fused or deformed.

WELDING TECHNIQUES

SET THE CONTACT TIP TO WORK DISTANCE (CTWD)

WARNING: When inching, the wire is always electrically “hot” to ground, except on wire feeders with a “cold inch” feature.

CTWD is measured from the end of the contact tip to the work. Maintain this length within $\pm 1/8$ " (3.2mm.) for $CTWD \leq 1$ " (25 mm) or within $\pm 1/4$ " (6.4 mm) for $CTWD > 1$ " (25 mm) during welding.

To obtain the proper CTWD when using an insulated guide:

1. Remove the insulated guide from the end of the gun tube.
2. Inch the wire out beyond the end of the contact tip until you obtain the CTWD specified for each size and type electrode.
3. Replace insulated guide.
4. The length of wire protruding from the end of the guide is visible stickout. Maintaining this visible CTWD with the guide in place gives the correct CTWD while welding. For wires using the T12313 Thread Protector, the contact tip is exposed. **This tip should NEVER be allowed to touch the work when the power source output contactor is closed, as it is electrically “hot”.**

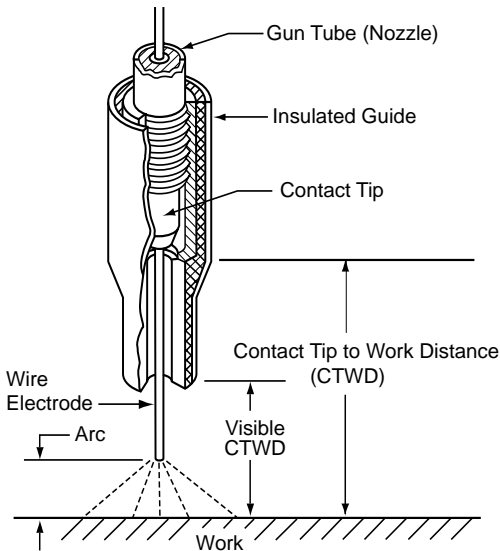

WELDING TECHNIQUES

SET THE WIRE FEED SPEED

Adjust the wire feed speed using the WFS control on the wire feeder. Set to the suggested procedures. See pages 30-39. The approximate amperage corresponding to each WFS at the specified CTWD is also listed in the table. Amperage depends on wire feed speed and CTWD. If the CTWD is shortened, amperage will increase. If a wire feed speed meter is not available it may be measured by running the wire out for 6 seconds, then measure the length of wire fed and multiply by 10 to get the WFS in inches per minute (in/min).

START THE ARC

With the proper visible CTWD set, position the gun with the wire lightly touching the work. Avoid pushing the wire into the joint before starting the arc. Press the gun trigger to start the weld. Release the trigger and pull the gun from the work to stop the arc.

Some welders accustomed to manual welding with stick electrode tend to push the wire into the joint as it burns away. Since the wire is mechanically fed, this must be avoided.

SET THE VOLTAGE

Adjust the voltage to the suggested procedures as measured by the wire feeder voltmeter or voltmeter placed between the wire feeder contact block and workpiece. See pages 30-39. The presence of surface porosity indicates that the arc voltage is too high and should be lowered. An excessively convex or ropey bead indicates that the voltage is too low. Increase the voltage setting to reduce the convexity or ropey appearance of the bead. Also, check for poor work cable connections, undersized or damaged work cables, and poor cable clamps.

TRAVEL SPEED

As in all welding processes, use a travel speed which keeps the arc at the front edge of the weld puddle and produces the desired weld size. Maintain a uniform travel speed. The best way to do this is to maintain a uniform distance between the wire and the molten slag behind the wire. Travel speed is usually faster with Innershield wire than with stick electrodes because of the higher deposit rate. Many welders tend to move too slowly when they first weld with Innershield wire.

WELDING TECHNIQUES

LOADING 13-14 LB. (5.9-6.5 kg) COILS ON A 2” (50mm) SPINDLE

1. Remove the locking collar and the cover plate from K435 spindle adapter.
3. Unpack the 14 lb. (6.4kg) coil of wire. Be sure not to bend the side tabs of the coil liner. Straighten any tabs that may have been bent.
4. Remove the start end of the coil, cut off the bent end, straighten the first six inches. Be sure the cut end of the wire is round and burr free before the new coil into the drive rolls. Thread it through the feeding wire feed liner until about four inches of wire is exposed.
5. Replace the front reel cover and center clamping collar. **To prevent the wire from dereeling**, keep the reel from turning and tighten the clamping collar securely.
6. See wire feeder operating manual for instructions on loading the wire into the drive roll and guide tubes.

WELDING TECHNIQUES

HANDLING POOR FITUP

Innershield bridges gaps better than most welding processes. When using NS-3M at 3" (76mm) CTWD, temporarily increasing the visible CTWD to as much as 3-1/4" (83mm) helps reduce penetration and burnthrough to bridge gaps. Poor fitup may require a small, temporary increase in visible CTWD or a reduction in WFS setting.

USE A DRAG TECHNIQUE

Tilt the gun back away from the weld puddle in the direction of travel about the same as required in stick electrode welding. If slag tends to run ahead of the arc, increase the drag angle. However, if the drag angle becomes too great, erratic arc action and excessive arc blow will result in porosity and poor bead shape.

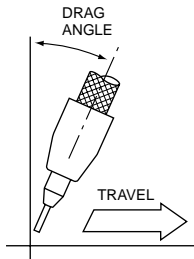

USE THE PROPER WIRE ANGLE TO JOINT

Horizontal Fillets

For 1/4" (6mm) and smaller fillets, point the wire at the joint. The wire angle to the joint should be about 40°.

For best bead shape on 5/16" (8mm) and large horizontal fillets, point the wire at the bottom plate close to the corner of the joint. The angle between the wire and the bottom plate should be less than 45°. Using this position, the molten metal washes onto the vertical plate.

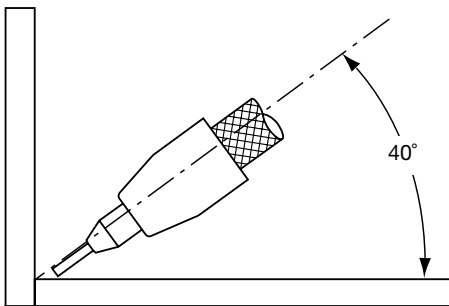

WELDING TECHNIQUES

MAKING VERTICAL UP WELDS

Use 5/64" (2.0mm) size and less.

NR-202	NR-203M
NR-203MP	NR-203 Nickel (1%)
NR-211-MP	NR-212
NR-232	NR-233

Smaller sizes, 5/64" and less are recommended for all position welding.

When welding out-of-position, don't whip, break the arc, move out of the puddle or move too fast in any direction. Use WFS in the low portion of the range. General techniques are illustrated below. Experience will show how much hesitation and upward step is required for high quality welds.

Generally, keep the wire nearly perpendicular to the joint as illustrated. The maximum angle above perpendicular may be required if porosity becomes a problem.

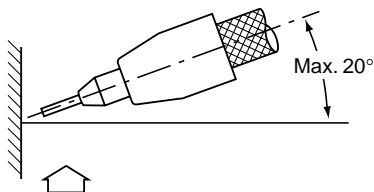

Groove Welds

1. Make a distinct hesitation at the outer edges of bevel.
2. Minimize each upward step. Do not step up at the edges. Come straight out from the hesitation point and move up across the weld.

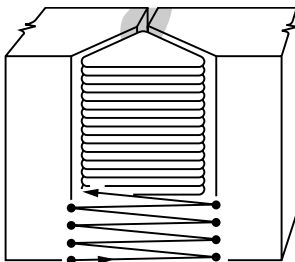

WELDING TECHNIQUES

Vertical Up Fillet and Lap Welds

1. Make larger welds with the following techniques:
 - a. On 1/4" (6mm) welds, a short side-to-side motion is usually sufficient.
 - b. On larger welds, use a triangular weave (see number 1 in the sketch below) with a distinct hesitation at the outer edges for the first pass.
 - c. Use a side-to-side weave (see number 2 in the sketch below) similar to that used for butt welds on the second and later passes. The first pass should have a face width of 5/16" - 3/8" (8 - 10mm) before starting this weave.

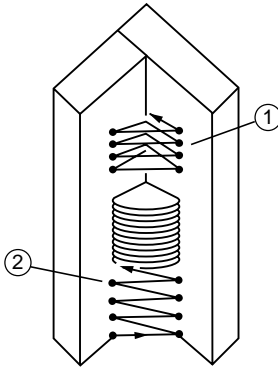

MAKING DOWNHILL AND VERTICAL DOWN WELDS

With NR-202, NR-203 (types), NR-207, NR-208-H, NR-211-MP, NR-212

Make 1/4" (6mm) or smaller welds using vertical down techniques. The excellent high speed welding characteristics are best utilized for low cost single pass welds by positioning the work downhill or vertical down. About a 60° downhill angle with 5/64" or 3/32" (2.0 or 2.4mm) electrode usually provides maximum speed.

Use stringer beads and currents in the middle to high portion of the range. Tip the electrode up so that arc force helps hold the molten metal in the joint. Move as fast as possible consistent with desired bead shape.

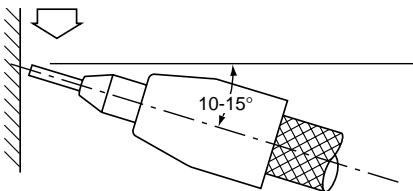

WELDING TECHNIQUES

WORKING WITH NS-3M

To calculate electrical stickout, subtract 1/4" from CTWD.

.120" (3.0mm) NS-3M

When using the long CTWD of 3" to 4" (75 to 100mm), the long length of wire beyond the contact tip has greater electrical resistance. Because of the greater resistance, the wire is heated to a higher temperature so it melts more rapidly in the arc to increase deposition rates and lower weld cost.

Using a long CTWD reduces penetration and makes starts more difficult. The long distance from the contact tip to the work also allows the wire to wander more than if a shorter CTWD is used.

Linc-Fill welding with 4" (100mm) CTWD is generally limited to 9/16" (8mm) (leg) and larger flat fillets, multiple pass flat fillets and the fill passes of flat deep groove butt joints.

When changing the insulated guide tips to increase CTWD from 3" to 4" (75 to 100mm), the meter voltage reading must be increased by 2 or 3 volts to maintain a good flat bead. The current (or WFS) control setting must also be adjusted to increase the wire feed speed to obtain the same welding current.

For welding with 4" (100mm) CTWD, follow the basic instructions under "Start The Arc", on page 19. Start with 3/4" (19mm) visible CTWD. When the arc is established, increase the CTWD to the normal 1-5/8" (41mm) visible CTWD using the proper insulated guide. See the tables on pages 30-39 for the proper CTWD for each size wire.

OPERATING GUIDE

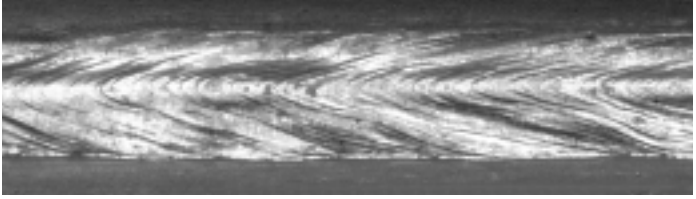

Well made Innershield welds have excellent appearance.

TROUBLESHOOTING

To Eliminate Porosity (In order of importance)

1. Clean the joint from moisture, rust, oil, paint and other contaminants
2. Decrease voltage
3. Increase CTWD
4. Increase WFS
5. Decrease drag angle
6. Decrease travel speed

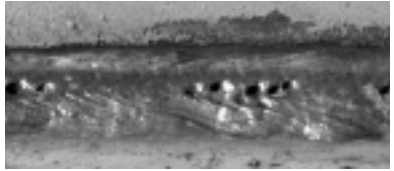

To Eliminate a Ropy Convex Bead (In order of importance)

1. Increase voltage (within wire specifications)
2. Decrease CTWD
3. Decrease WFS
4. Decrease travel speed
5. Decrease drag angle



To Reduce Spatter (In order of importance)

1. Adjust voltage
2. Decrease drag angle
3. Decrease CTWD
4. Increase WFS
5. Decrease travel speed

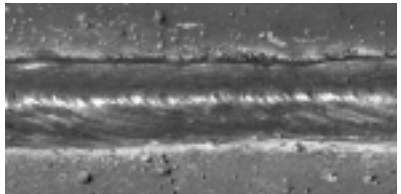

To Correct Poor Penetration (In order of importance)

1. Decrease CTWD
2. Increase WFS
3. Decrease voltage
4. Decrease travel speed
5. Decrease drag angle

OPERATING GUIDE

To Minimize Arc Blow (In order of importance)

Arc blow occurs when the arc stream does not follow the shortest path between the electrode and the workpiece.

1. Move work connection locations
2. Decrease drag angle
3. Increase CTWD
4. Decrease WFS and voltage
5. Decrease travel speed

To Eliminate Stubbing (In order of importance)

Stubbing occurs when the wire drives through the molten puddle and hits the bottom plate tending to push the gun up.

1. Increase voltage
2. Decrease WFS
3. Decrease CTWD
4. Decrease drag angle

Equipment Troubleshooting Instructions are included in the operating manuals for the wire feeder and power source. Be sure to confirm the equipment is operating properly.

EFFECT OF OPERATING VARIABLES

The four major operating variables, arc voltage, wire feed speed (WFS), travel speed and CTWD, are interdependent. If one is changed, usually the other three must also be adjusted.

Arc Voltage

If WFS, travel speed and CTWD are held constant, changing the arc voltage will have the following effects:

1. Higher arc voltage results in a wider and flatter bead.
2. Excessive arc voltage causes porosity.
3. Low voltage causes a convex ropey bead.
4. Extremely low voltage will cause the wire to stub on the plate.
That is, the wire will dive through the molten metal and strike the joint bottom, tending to push the gun up.

Wire Feed Speed (WFS) - (or welding current)

If arc voltage, travel speed and CTWD are held constant, WFS variations have the following major effects:

1. Increasing the WFS increases melt-off and deposition rates.
2. Excessive WFS produces convex beads. This wastes weld metal and results in poor appearance.

OPERATING GUIDE

3. Increasing WFS also increases the maximum voltage which can be used without porosity. Lowering the WFS requires lowering the voltage to avoid porosity.

As the WFS is increased, the arc voltage must also be increased to maintain proper bead shape.

Travel Speed

If arc voltage, WFS and CTWD are held constant, travel speed variations have the following major effects:

1. Too high a travel speed increases the convexity of the bead and causes uneven edges.
2. Too slow a travel speed results in slag interference, slag inclusions and a rough, uneven bead.

Contact Tip to Work Distance (CTWD)

If the voltage and wire feed speed setting and the travel speed are held constant, variations in CTWD have the following major effects:

1. Increasing CTWD reduces the welding current. Decreasing CTWD increases current.
2. Increasing CTWD reduces actual arc voltage and results in more convex beads and reduces the tendency of porosity.
3. Momentarily increasing CTWD can be used to reduce burn-through tendency when poor fitup is encountered.

WELDER QUALIFICATION TEST

1. Remove mill scale and other contaminants from mating surfaces of backing and test plates.
2. Preheat to 300°F for 3/8" (10 mm) thick welder qualification test.
3. Attach backing so that it is tight (NO GAP)
4. Use the least drag angle to keep the slag back from the arc.
5. Aging at 220°F, (104°C) for 48 hrs. is permitted by AWS A5.20-95, paragraph A8.3. A naturally aged specimen may take months to achieve the specified properties.

Because design, fabrication, erection and welding variables affect the results obtained in applying this type of information, the serviceability of a product or structure is the responsibility of the builder/user.

STORING INNERSHIELD ELECTRODES

In general, Innershield electrodes will produce weld deposits which achieve diffusible hydrogen levels below 16 ml per 100 grams deposited metal. These products, like other products which produce deposits low in diffusible hydrogen, must be protected from exposure to the atmosphere in order to;

- (a) maintain hydrogen levels as low as possible
- (b) prevent porosity during welding
- (c) prevent rusting of the product.

Accordingly, the following storage conditions are recommended for Innershield electrodes in their original, unopened packages:

The recommended storage conditions are such that they maintain environmental conditions above the dew point to prevent moisture condensation on product.

For best results, electrode should be consumed as soon as practicable. Properly stored electrode may be kept three years or more from the date of manufacture. Consult your Lincoln distributor or sales representative if there is a question as to when the electrode was made.

Once the electrode packaging is opened, Innershield electrodes can be contaminated by atmospheric moisture. Care has been taken in the design of these products to ensure that they are resistant to moisture pick-up; however, condensation of moisture from the atmosphere onto the surface of the electrode can be sufficient to degrade the product.

The following minimum precautions should be taken to safeguard the product after opening the original package. Electrode should be used within approximately 1 week after opening the original package. Opened electrodes should not be exposed to damp moisture conditions or extremes in temperature and/or humidity where surface condensation can occur. Electrodes mounted on wire feeders should be protected against condensation. It is recommended that electrode removed from its original packaging be placed in poly bags (4 mil minimum thickness) when not in use.

Innershield electrodes will evidence high moisture levels in the form of gas tracks, higher spatter and porosity. Any rusty electrode should be discarded.

STORING INNERSHIELD ELECTRODES

Innershield Products Used for Applications Requiring More Restrictive Hydrogen Control (-H Electrodes)

The AWS specifications for flux-cored electrodes, AWS A5.20 and A5.29, state that “Flux-cored arc welding is generally considered to be a low hydrogen welding process”. Further, these specifications make available optional supplemental designators for maximum diffusible hydrogen levels of 4, 8 and 16 ml per 100 grams of deposited weld metal.

Some Innershield products have been designed and manufactured to produce weld deposits meeting these more stringent diffusible hydrogen requirements. These electrodes are usually distinguished by an “H” added to the product name. These electrodes will remain *relatively* dry under recommended storage conditions in their original, unopened package or container.

For applications in which the weld metal hydrogen must be controlled (usually H8 or lower), or where shipping and storage conditions are not controlled or known, only hermetically sealed packaging is recommended. Many Innershield electrodes are available in hermetically sealed packages.

Once the package has been opened, the electrode should be used as soon as practicable.

NR-211-MP WELDING PROCEDURES

HORIZONTAL, FLAT, DOWNHILL AND VERTICAL DOWN

Plate Size – T (in)	14 GA	10 GA
Pass	1	1
Electrode Polarity	5/64" NR-211-MP MP DC(-)	
CTWD	1"	1"
Wire Feed Speed (in/min)	50	75
Arc Volts	16 ⁽¹⁾	18 ⁽¹⁾
Travel Speed (in/min)	As Req'd	As Req'd
Deposit Rate (lbs/hr)	2.9	4.5

(1) Use 1 volt lower for Vertical Down and Overhead.

HORIZONTAL, FLAT, DOWNHILL VERTICAL DOWN AND OVERHEAD

Plate Size – T (in)	16 GA	12 GA
Pass	1	1
Electrode Polarity	.068" NR-211-MP MP DC(-)	
CTWD	1"	1"
Wire Feed Speed (in/min)	40	60
Arc Volts	15	16
Travel Speed (in/min)	As Req'd	As Req'd
Deposit Rate (lbs/hr)	1.7	2.6

Because design, fabrication, erection and welding variables affect the results obtained in applying this type of information, the serviceability of a product or structure is the responsibility of the builder/user.

NR-232 .068" WELDING PROCEDURES

VERTICAL UP AND OVERHEAD BUTT WELDS – OPEN ROOT

Plate Size – T (in)	3/4 and up	
Pass	1	2 & up
Electrode Polarity	.068" NR-232 DC(–)	
CTWD Drag Angle	1 – 1-1/2 " 5 – 30°	3/4 – 1" 0 – 30°
Wire Feed Speed (in/min)	110 – 135	150 – 170
Arc Volts Travel Speed (in/min)	18 – 19 19 – 21 As Req'd	19 – 21 20 – 22 As Req'd
Deposit Rate (lbs/hr)	3.8 – 4.7	5.2 – 6.0

FLAT AND HORIZONTAL FILLET WELDS

Plate Size – T (in) Leg Size – L (in) Pass	5/16 1/4 1	3/8, 5/16 1	3/8 & Up over 5/16 As req'd
Electrode Polarity	.068" NR-232 DC(–)		
CTWD Drag Angle	3/4 - 1-1/4" 20 – 30°		
Wire Feed Speed (in/min)	165 – 320		165 – 250
Arc Volts Travel Speed (in/min)	20 – 22 15	25 – 27 17	20 – 22 23 – 24 As Req'd
Deposit Rate (lbs/hr)	5.9	11.3	5.9 – 8.6

Because design, fabrication, erection and welding variables affect the results obtained in applying this type of information, the serviceability of a product or structure is the responsibility of the builder/user.

NR-232 .068" WELDING PROCEDURES

ALL POSITION FILLET WELDS

Plate Size – T (in) Leg Size – L (in) Pass	5/16 1/4 1	3/8 5/16 1	3/8 & Up over 5/16 As req'd
Electrode Polarity	.068" NR-232 DC(–)		
CTWD Drag Angle	3/4 – 1" 0 – 30°		
Wire Feed Speed (in/min)	130 – 165		
Arc Volts Travel Speed (in/min)	6.5 – 9.5	19 – 21 21 – 23 5 – 7	As Req'd
Deposit Rate (lbs/hr)	4.5 – 5.9		

VERTICAL UP AND OVERHEAD BUTT – STEEL BACKUP

Plate Size – T (in)	3/8 & up	
Pass	1	2 & up
Electrode Polarity	.068" NR-232 DC(–)	
CTWD Drag Angle	3/4 – 1-1/4" 5 – 20°	
Wire Feed Speed (in/min)	155	165
Arc Volts Travel Speed (in/min)	21 4.3 – 5.6	22 As Req'd.
Deposit Rate (lbs/hr)	5.5 – 5.9	

Because design, fabrication, erection and welding variables affect the results obtained in applying this type of information, the serviceability of a product or structure is the responsibility of the builder/user.

NR-232 .068" WELDING PROCEDURES

FLAT AND HORIZONTAL BUTT WELDS

Plate Size – T (in)	3/4 & up		
Pass	1	2 & up	Cap Passes (Horizontal)
Electrode Polarity	.068" NR-232 DC(–)		
CTWD Drag Angle	1 – 1-1/2" 5 – 30°	3/4 – 1-1/4" 0 – 30°	
Wire Feed Speed (in/min)	110 – 135	250 – 275	180 – 195
Arc Volts	18–20/19–21	20–22/23–25	20–21/23–24
Travel Speed (in/min)	4.3 – 5.6	As Req'd	As Req'd
Deposit Rate (lbs/hr)	3.8 – 4.6	8.6 – 9.5	6.2 – 6.8

Because design, fabrication, erection and welding variables affect the results obtained in applying this type of information, the serviceability of a product or structure is the responsibility of the builder/user.

NR-232 .072" WELDING PROCEDURES

ALL POSITION FILLET WELDS

Plate Size – T (in)	5/16	3/8,	1/2 & up
Leg Size – L (in)	1/4	5/16	3/8 & up
Pass	1	1	As req'd
Electrode Polarity	.072" NR-232 DC(–)		
CTWD	3/4 – 1"	3/4 – 1"	3/4 – 1"
Drag Angle	0°	0 – 30°	0 – 30°
Wire Feed Speed (in/min)	155 – 170	155 – 170	155 – 170
Arc Volts	20 – 23	20 – 23	20 – 23
Travel Speed (in/min)	9.5	6.5	As Req'd
Deposit Rate (lbs/hr)	6.0 – 6.5	6.0 – 6.5	6.0 – 6.5

VERTICAL UP AND OVERHEAD BUTT WELDS – OPEN ROOT

Plate Size – T (in)	3/4 & up		
Pass	1	2 & up	cap
Electrode Polarity	.072" NR-232 DC(–)		
CTWD	1 – 1-1/2"	3/4 – 1"	3/4 – 1"
Drag Angle	5 – 30°	0 – 30° ⁽¹⁾	0 – 30°
Wire Feed Speed (in/min)	85 – 110	155	155
Arc Volts	17 – 18	22	20
Travel Speed (in/min)	As Req'd	As Req'd	As Req'd
Deposit Rate (lbs/hr)	3.3 – 4.3	6.0	6.0

⁽¹⁾ At a travel speed of 10 in./min, a slight push angle is preferred.

Because design, fabrication, erection and welding variables affect the results obtained in applying this type of information, the serviceability of a product or structure is the responsibility of the builder/user.

NR-232 .072" WELDING PROCEDURES

VERTICAL UP AND OVERHEAD BUTT WELDS – STEEL BACKUP

Plate Size – T (in)	3/8 & up		
Pass	1	2 & up	cap
Electrode Polarity	.072" NR-232 DC(–)		
CTWD	3/4"	3/4"	3/4"
Drag Angle	0°	5 – 20°	5 – 20°
Wire Feed Speed (in/min)	155	155	155
Arc Volts	22	22	20
Travel Speed (in/min)	As Req'd	As Req'd	As Req'd
Deposit Rate (lbs/hr)	6.0	6.0	6.0

FLAT AND HORIZONTAL FILLET WELDS

Plate Size – T (in)	5/16	3/8	3/8, & up
Leg Size – L (in)	1/4	5/16	over 5/16
Pass	1	1	As req'd
Electrode Polarity	.072" NR-232 DC(–)		
CTWD	3/4 – 1-1/4"	3/4 – 1-1/4"	3/4 – 1-1/4"
Drag Angle	20 – 30°	20 – 30°	20 – 30°
Wire Feed Speed (in/min)	290	290	250
Arc Volts	23 – 24	23 – 24	21 – 22
Travel Speed (in/min)	16	11.5	As Req'd
Deposit Rate (lbs/hr)	11	11	9.5

⁽¹⁾ For maximum penetration, point the electrode into the corner or slightly into the butting corner.

Because design, fabrication, erection and welding variables affect the results obtained in applying this type of information, the serviceability of a product or structure is the responsibility of the builder/user.

NR-232 .072" WELDING PROCEDURES

FLAT AND HORIZONTAL BUTT WELDS

Plate Size – T (in)	3/4 & up		
Pass	1	2-cap	Cap Passes (Horizontal)
Electrode Polarity	.072" NR-232 DC(–)		
CTWD Drag Angle	1-1/4 – 1-1/2" 5 – 30°	3/4 – 1-1/4" 0 – 30°	3/4 – 1-1/4" 0 – 30°
Wire Feed Speed (in/min)	85 – 110	220 – 250	155 – 170
Arc Volts Travel Speed (in/min)	17 – 18 As Req'd	20 – 22 As Req'd	20 – 21 As Req'd
Deposit Rate (lbs/hr)	3.3 – 4.5	8.5 – 9.5	6.0 – 6.5

Because design, fabrication, erection and welding variables affect the results obtained in applying this type of information, the serviceability of a product or structure is the responsibility of the builder/user.

NR-232 5/64" WELDING PROCEDURES

ALL POSITION FILLET WELDS

Plate Size – T (in)	5/16	3/8	1/2	Over 1/2
Leg Size – L (in)	1/4	5/16	3/8	Over 3/8
Pass	1	1	1	As req'd
Electrode Polarity	5/64" NR-232 DC (–)			
CTWD	3/4" ⁽²⁾	3/4" ⁽²⁾	7/8" ⁽²⁾	7/8" ⁽²⁾
Drag Angle	0°	0 – 20°	0 – 20°	0 – 20°
Wire Feed Speed (in/min)	120	130	130	130
Arc Volts	19 – 20	20 – 21	20 – 21	20 – 21
Travel Speed (in/min)	8	6	4.5	As Req'd
Deposit Rate (lbs/hr)	5.7	6.2	6.2	6.2

⁽²⁾ For best slag control, start at 1", then reduce.

FLAT AND HORIZONTAL FILLET WELDS

Plate Size – T (in)	5/16	3/8	Over 3/8
Leg Size – L (in)	1/4	5/16	over 5/16
Pass	1	1	As req'd
Electrode Polarity	5/64" NR-232 DC (–)		
CTWD	1"	1"	1"
Drag Angle	20 – 30°	20 – 30°	20 – 30°
Wire Feed Speed (in/min)	175	175	175
Arc Volts	21.5 – 22.5	21.5 – 22.5	20.5 – 21.5
Travel Speed (in/min)	14	10.5	As Req'd
Deposit Rate (lbs/hr)	8.4	8.4	8.4

Because design, fabrication, erection and welding variables affect the results obtained in applying this type of information, the serviceability of a product or structure is the responsibility of the builder/user.

NR-232 5/64" WELDING PROCEDURES

FLAT AND HORIZONTAL BUTT WELDS

Plate Size – T (in)	3/8 & up	
Pass	1 ⁽¹⁾	2 & up
Electrode Polarity	5/64" NR-232 DC(–)	
CTWD	1-1/4 – 1-1/2"	1"
Drag Angle	5 – 30°	5 – 30°
Wire Feed Speed (in/min)	65 – 70	180
Arc Volts	17 – 17.5	22 – 23
Travel Speed (in/min)	As Req'd	5 – 9
Deposit Rate (lbs/hr)	2.9 – 3.2	8.7

⁽¹⁾ With a steel backup, start with the second pass procedure and a minimum root opening of 5/16".

VERTICAL UP BUTT WELDS – OPEN ROOT

Plate Size – T (in)	3/8 & up		
Pass	1	2	3 & up
Electrode Polarity	5/64" NR-232 DC(–)		
CTWD	1-1/4 – 1-1/2	1" ⁽²⁾	1" ⁽²⁾
Drag Angle	5 – 40°	0 – 30°	0 – 30°
Wire Feed Speed (in/min)	60 – 65	115	130
Arc Volts	16 – 17	19 – 20	20 – 21
Travel Speed (in/min)	As Req'd	3 – 5	3 – 5
Deposit Rate (lbs/hr)	2.7 – 2.9	5.5	6.2

⁽²⁾ For best slag control, start at 1-1/4", then reduce.

Because design, fabrication, erection and welding variables affect the results obtained in applying this type of information, the serviceability of a product or structure is the responsibility of the builder/user.

NR-232 5/64" WELDING PROCEDURES

VERTICAL UP AND OVERHEAD BUTT WELDS – STEEL BACKUP

Plate Size – T (in)	3/8 & up	
Pass	1	2 & up
Electrode Polarity	5/64" NR-232 DC(–)	
CTWD	1" ⁽¹⁾	1" ⁽¹⁾
Drag Angle	0 – 30°	0 – 30°
Wire Feed Speed (in/min)	115	130
Arc Volts	19 – 20	20 – 21
Travel Speed (in/min)	3 – 5	3 – 5
Deposit Rate (lbs/hr)	5.5	6.2

⁽¹⁾ For best slag control, start at 1-1/4", then reduce.

Because design, fabrication, erection and welding variables affect the results obtained in applying this type of information, the serviceability of a product or structure is the responsibility of the builder/user.

OPERATING PARAMETERS

Wire Polarity, AWS Class. CTWD In (mm) Wire Weight	Wire Feed Speed in/min (m/min)		Arc Voltage (volts)	Approx. Current (amps)	Deposit Rate lbs/hr (kg/hr)	
(1) .120" NR-1 or NR-5 (DC+) E70T-3 1-3/8" (35) 2.63 lbs/1000"	140	(3.6)	20	450	18.4	(8.3)
	160	(4.1)	21	500	22.0	(10.0)
	240	(6.1)	23	700	33.0	(15.0)
	320	(8.1)	25	850	43.0	(19.5)
(1) 5/32" NR-1 (DC+) E70T-3 1-1/2" (38) 4.07 lbs/1000"	100	(2.5)	21	600	21.2	(9.6)
	130	(3.3)	23	810	30.0	(13.6)
	150	(3.8)	24	900	35.0	(15.9)
	220	(5.6)	26	1120	48.3	(21.9)
(1) 3/32" NR-5 (DC+) E70T-3 1-1/4" (32) 1.60 lbs/1000"	100	(2.5)	22	340	7.8	(3.5)
	150	(3.8)	23	435	12.3	(5.6)
	200	(5.1)	24	510	16.9	(7.6)
	250	(6.4)	26	575	21.4	(9.7)
(1) 3/32" NR-131 (DC+) E70T-10 1-1/2" (38) 1.58 lbs/1000"	150	(3.8)	25	390	11.6	(5.3)
	200	(5.1)	26	490	15.6	(7.1)
	250	(6.4)	26	570	19.6	(8.9)
	425	(10.8)	27	810	33.6	(15.2)
(1) .045" NR-152 (DC-) E71T-14 5/8" (16) .39 lbs/1000"	60	(1.5)	15	95	1.1	(0.5)
	90	(2.3)	16	135	1.8	(0.8)
	120	(3.0)	17	160	2.5	(1.1)
	150	(4.6)	18	180	3.2	(1.4)
(1) .062" NR-152 (DC-) E71T-14 5/8" (16) .74 lbs/1000"	30	(0.8)	13	90	1.2	(0.5)
	50	(1.3)	15	140	2.0	(0.9)
	70	(1.8)	16	185	2.8	(1.3)
	110	(2.8)	19	265	4.4	(2.0)
(1) .068" NR-152 (DC-) E71T-14 3/4" (19) .91 lbs/1000"	40	(1.0)	13	95	1.9	(0.9)
	50	(1.3)	14	120	2.4	(1.1)
	80	(2.0)	16	190	3.9	(1.8)
	110	(2.8)	20	240	5.4	(2.4)
(1) 5/64" NR-152 (DC-) E71T-14 1" (25) 1.15 lbs/1000"	40	(1.0)	16	125	2.5	(1.1)
	80	(2.0)	19	260	4.9	(2.2)
	100	(2.5)	21	310	6.1	(2.7)
	125	(3.2)	24	355	7.6	(3.4)

(1) Single pass welding only.

OPERATING PARAMETERS

Wire Polarity, AWS Class. CTWD In (mm) Wire Weight	Wire Feed Speed in/min (m/min)	Arc Voltage (volts)	Approx. Current (amps)	Deposit Rate lbs/hr (kg/hr)
5/64" NR-202 (DC-) E71T-7 1-1/4" (32) 1.09 lbs/1000"	50 (1.3) 100 (2.5) 150 (3.8) 200 (5.1) 230 (5.8)	19 20 21 22 23	150 235 305 365 400	2.0 (0.9) 5.1 (2.3) 8.3 (3.8) 11.4 (5.2) 13.3 (6.0)
.068" NR-203MP (DC-) E71T-8J 1" (25) .78 lbs/1000"	70 (1.8) 90 (2.3) 120 (3.0) 150 (3.8)	16 18 20 23	145 180 225 265	2.3 (1.0) 3.2 (1.5) 4.3 (2.0) 5.1 (2.3)
5/64" NR-203MP (DC-) E71T-8J 1" (25) 1.03 lbs/1000"	50 (1.3) 90 (2.3) 120 (2.8) 140 (3.6)	16 19 20 22	130 220 280 310	1.9 (0.9) 4.2 (1.9) 5.3 (2.4) 6.8 (3.1)
5/64" NR-203 Ni (1%) (DC-) E71T8-Ni1 1" (25) 1.52 lbs/1000"	16 50 18 70 20 110 21 120 22 140	(1.3) (1.8) (2.8) (3.1) (3.6)	145 195 275 290 310	2.3 (1.0) 3.3 (1.5) 5.3 (2.4) 5.8 (2.5) 6.9 (3.1)
3/32" NR-203 Ni (1%) (DC-) E71T8-Ni1 1" (25) 1.52 lbs/1000"	50 (1.3) 70 (1.8) 95 (2.4) 110 (2.8) 130 (3.3)	18 19 21 22 23	215 260 315 345 385	3.6 (1.6) 5.1 (2.3) 7.0 (3.2) 8.1 (3.7) 9.6 (4.4)
(2) .068" NR-207 (DC-) E71T8-K6 1" (25) .78 lbs/1000"	80 (2.0) 105 (2.7) 120 (3.0) 170 (4.3)	17 18 19 21	190 220 245 300	3.0 (1.4) 3.9 (1.8) 4.5 (2.0) 6.5 (2.9)

- (2) This electrode has been specifically designed for the demanding needs of pipe welding.

OPERATING PARAMETERS

Wire Polarity, AWS Class. CTWD In (mm) Wire Weight	Wire Feed Speed in/min (m/min)	Arc Voltage (volts)	Approx. Current (amps)	Deposit Rate lbs/hr (kg/hr)
5/64" NR-207 & NR-207-H (2) (DC-) E71T8-K6	70 (1.8) 90 (2.3) 110 (2.8) 130 (3.3)	17 19 20 20	205 245 275 300	3.4 (1.5) 4.5 (2.0) 5.5 (2.5) 6.5 (2.9)
.035" NR-211-MP (DC-) E71T-11	14 50 15 70 16 90 16.5 110	(1.3) (1.8) (2.3) (2.8)	30 60 90 120	.65 (0.3) 1.00 (0.5) 1.35 (0.6) 1.70 (0.8)
.045" NR-211-MP (DC-) E71T-11	70 (1.8) 90 (2.3) 110 (2.8) 130 (3.3)	15 16 17 18	120 140 160 170	1.1 (0.5) 1.7 (0.8) 2.3 (1.0) 2.7 (1.2)
.068" NR-211-MP (DC-) E71T-11	40 (1.0) 75 (1.9) 130 (3.3) 175 (4.4)	15 18 20 23	125 190 270 300	1.7 (0.8) 3.4 (1.5) 6.1 (2.8) 8.4 (3.8)
5/64" NR-211-MP (DC-) E71T-11	50 (1.3) 75 (1.9) 120 (3.0) 160 (4.1)	16 18 20 22	180 235 290 325	2.9 (1.3) 4.5 (2.0) 7.4 (3.4) 10.0 (4.5)
3/32" NR-211-MP (DC-) E71T-11	50 (1.3) 75 (1.9) 120 (3.0) 160 (4.1)	16 19 20 22	245 305 365 400	4.2 (1.9) 6.4 (2.9) 8.7 (3.9) 11.3 (5.1)
.045" NR-212 (DC-) E71TG-G	55 (1.4) 70 (1.8) 110 (2.8) 150 (3.8)	14 15 17 19	75 90 135 170	1.1 (0.5) 1.4 (0.6) 2.2 (1.0) 3.0 (1.4)
.068" NR-212 (DC-) E71TG-G	60 (1.5) 75 (1.9) 120 (3.0) 175 (4.4)	16 18 20 22	145 180 230 275	2.4 (1.1) 3.2 (1.4) 5.2 (2.3) 7.5 (3.4)
5/64" NR-212 (DC-) E71TG-G	60 (1.5) 75 (1.9) 110 (2.8) 150 (3.8)	16 18 20 22	200 225 275 325	3.3 (1.5) 4.1 (1.8) 6.2 (2.8) 8.4 (3.8)

(2) This electrode has been specially designed for the demanding needs of pipe welding.

Note: These are typical operating procedures and are not intended to serve as specific procedures for any applications.

OPERATING PARAMETERS

Wire Polarity, AWS Class. CTWD In (mm) Wire Weight	Wire Feed Speed in/min (m/min)	Arc Voltage (volts)	Approx. Current (amps)	Deposit Rate lbs/hr (kg/hr)
.068" NR-232 (DC-) E71T-8 1" (25) .75 lbs/1000"	110 (2.7) 150 (3.8) 195 (5.0) 320 (7.4)	19 20 23.5 26	195 250 300 400	3.9 (1.8) 5.3 (2.4) 7.0 (3.2) 11.4 (5.2)
.072" NR-232 (DC-) E71T-8 1" (25) .78 lbs/1000"	80 (2.0) 140 (3.6) 170 (4.3) 290 (7.4)	17 19.5 21.5 24	130 225 255 350	3.3 (1.5) 5.5 (2.5) 6.5 (2.9) 11.0 (5.0)
5/64" NR-232 (DC-) E71T-8 1" (25) 1.00 lbs/1000"	60 (1.5) 115 (2.9) 130 (3.3) 180 (4.6)"	17 18 20.5 22.5	145 260 285 365	2.7 (1.2) 5.5 (2.5) 6.2 (2.8) 8.7 (3.9)
5/64" NR-305 (DC+) E70T-6 1-3/8" (35) 1.05 lbs/1000"	175 (4.5) 260 (6.6) 280 (7.1) 325 (8.3)	22 24 25 26	295 385 405 435	8.8 (4.0) 13.1 (6.0) 14.2 (6.5) 16.4 (7.5)
3/32" NR-305 (DC+) E70T-6 1-3/4" (44) 1.39 lbs/1000"	160 (4.1) 240 (6.1) 300 (7.6) 400 (10.2)	22 25 28 34	330 425 475 525	11.0 (5.0) 16.7 (7.6) 21.0 (9.5) 28.0 (12.7)
5/64" NR-311 (DC-) E70T-7 1-1/2" (38) 1.07 lbs/1000"	100 (2.5) 160 (4.1) 240 (6.1) 300 (7.6)	21 25 26 28	190 275 355 410	5.0 (2.3) 8.0 (3.6) 12.4 (5.6) 15.8 (7.2)
3/32" NR-311 (DC-) E70T-7 1-3/4" (44) 1.62 lbs/1000"	75 (1.9) 135 (3.4) 150 (3.8) 270 (6.9)	21 24 25 30	200 300 325 450	5.4 (2.5) 10.2 (4.6) 11.4 (5.2) 22.0 (10.0)

OPERATING PARAMETERS

Wire Polarity, AWS Class. CTWD In (mm) Wire Weight	Wire Feed Speed in/min (m/min)	Arc Voltage (volts)	Approx. Current (amps)	Deposit Rate lbs/hr (kg/hr)
7/64" NR-311 (DC-) E70T-7 1-3/4" (44) 2.05 lbs/1000"	100 (2.5) 145 (3.7) 240 (6.1) 300 (7.6)	23 25 30 33	325 400 550 625	10.0 (4.5) 14.5 (6.6) 25.5 (11.6) 33.0 (15.0)
5/64" NR-311 Ni (DC-) E70TG-K2 1-1/4" (32) .93 lbs/1000"	100 (2.5) 160 (4.0) 200 (5.0) 240 (6.1)	22 26 27 28	170 235 270 295	3.9 (1.8) 6.5 (2.9) 8.3 (3.8) 10.0 (4.5)
3/32" NR-311 Ni (DC-) E70TG-K2 1-1/2" (38) 1.39 lbs/1000"	75 (1.9) 100 (2.5) 150 (3.8) 200 (5.0)	21 22 26 28	200 245 330 390	4.2 (1.9) 5.9 (2.7) 9.1 (4.1) 12.3 (5.6)
7/64" NR-311 Ni (DC-) E70TG-K2 1-3/4" (44) 1.89 lbs/1000"	100 (2.5) 140 (3.5) 200 (5.0) 240 (6.1)	23 25 29 30	310 370 470 520	8.4 (3.8) 11.8 (5.4) 17.0 (7.7) 20.4 (9.2)
5/64" NS-3M (DC+) E70T-4 2-1/4" (57) 1.03 lbs/1000"	200 (5.1) 240 (6.1) 260 (6.6) 300 (7.6)	30 31 31 32	280 315 330 350	10.1 (4.6) 12.1 (5.5) 13.2 (6.0) 15.2 (6.9)
3/32" NS-3M (DC+) E70T-4 3" (76) 1.53 lbs/1000"	110 (2.8) 150 (3.8) 230 (5.8) 275 (7.0)	29 30 32 (33)	250 300 400 450	8.2 (3.7) 11.7 (5.3) 18.3 (8.3) 22.0 (10.0)
.120" NS-3M (DC+) E70T-4 3" (76) 2.34 lbs/1000"	140 (3.6) 175 (4.4) 200 (5.1) 225 (5.7)	29 30 31 32	380 450 500 550	15.5 (7.0) 20.0 (9.1) 23.2 (10.5) 26.2 (11.9)
.120" NS-3M (DC+) E70T-4 4" (102) 2.34 lbs/1000"	210 (5.3) 250 (6.4) 300 (7.6) 355 (9.0)	36 37 38 39	450 500 550 600	25.0 (11.3) 29.0 (13.2) 34.0 (15.4) 39.5 (18.0)

OPERATING PROCEDURES

The suggested operating parameters listed in this publication are not intended to serve as specific procedures for any application. These suggested procedures represent the approximate procedure range of each individual electrode.

Arc voltage and/or wire feed speed may need to be adjusted depending upon welding position, type of weld, base steel surface condition or other factors. In general, use the highest voltage possible consistent with porosity-free welds.

CTWD is measured from the work surface to the contact tip. Maintain this length within $\pm 1/8"$ (3.2mm.) for CTWD $\leq 1"$ (25 mm) or within $\pm 1/4"$ (6.4 mm) for CTWD $> 1"$ (25 mm) during welding.

Contact your Authorized Lincoln Distributor or your local Lincoln Representative for specific procedures and techniques.

For more information on a particular Innershield wire, consult the C3.200.

INNERSHIELD GUN PARTS

Full Size Drawings* of Parts for K126 and K206 Guns

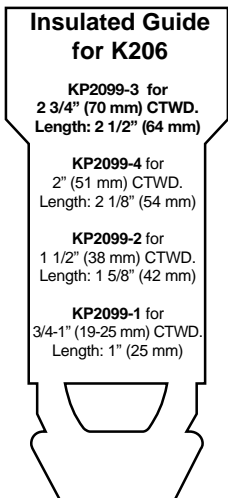
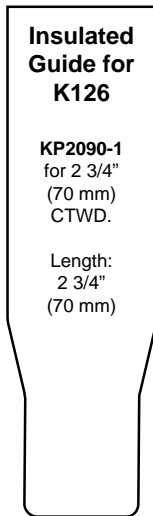
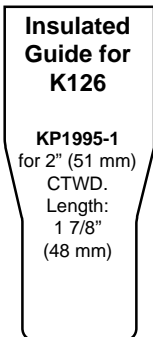

Electrode Part No.	Contact Tip Sizes (mm)
.062" (1.6)	KP2100-2B1-1/16
.068"-.072"(1.7-1.8)	KP2100-1B1-.072
5/64" (2.0)	KP2100-4B1-5/64
3/32" (2.4)	KP2100-3B1-3/32
Size stenciled on each tip.	

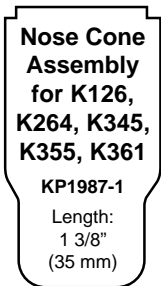

Thread Protector for 3/4" to 1-1/2"
(19 to 38 mm) CTWD.

Note: When using the KP2089-1 Thread Protector on a K126 or K309 gun with .062" through 3/32" (1.6 through 2.4 mm) electrode, visible CTWD and CTWD are identical.

* If sizes of insulated guides **NOT SHOWN**, order specific length needed by part number.

INNERSHIELD GUN PARTS

Full Size Drawings* of Parts for K115, K116 and K289 Guns

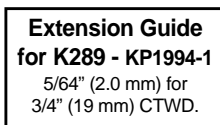
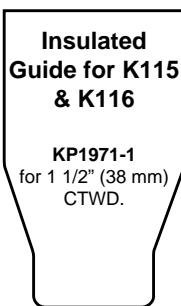
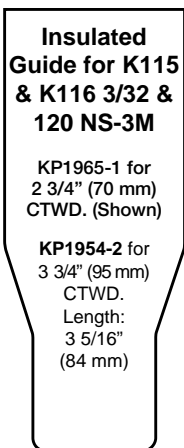

* All sizes of insulated guides **NOT SHOWN**, order specific length needed by part number.



Size stenciled on each tip.

Electrode Sizes (mm)	Contact Tip Part No.
1/16" (1.6)	KP2103-2B1-1/16
.068-.072" (1.7)	KP2103-1B1-.072
5/64" (2.0)	KP2103-5B1-5/64
3/32" (2.4)	KP2103-4B1-3/32
7/64 (2.8)	KP2103-6B1-7/64
.120" (3.0)	KP2103-3B1-120

For Gun ⁽¹⁾	Electrode Sizes Inches (mm)	Gun Tube (Nozzle) Part No.	45° Gun Tube (Nozzle) Part No.
K126 & K309	.062, .068, .072 5/64, 3/32	KP1920-1	---
K126 & K309		KP1914-2	---
K126		KP1914-1	---
K206		KP1909-1	---
K115 ⁽¹⁾	5/64	KP1921-1	---
---	3/32	KP1919-2	KP1919-1
---	7/64, .120	KP1907-2	KP1910-2
K116 ⁽¹⁾	3/32	KP1907-1	KP1910-1
---	7/64, .120	KP1908-2	---
K289 ⁽¹⁾	3/32	KP1908-1	---
---	7/64, .120	KP1915-4	KP1915-2
		KP1915-3	KP1915-1
For Gun	Electrode Sizes Inches (mm)	Gun Tube (Nozzle) ⁽¹⁾ Part No.	
K345-10 & K355-10	.068, .072 5/64	90° nozzle - KP1920-1 62° nozzle - KP1909-1 30° (Standard) - KP1914-2 30° (Long) - KP1914-1	

⁽¹⁾ Several standard cable lengths, nozzles and wire sizes are available. See price book or your local Lincoln distributor for more detailed information.



LINCOLN WELDING SCHOOL

NEED WELDING TRAINING?

The Lincoln Electric Company operates the oldest and most respected Arc Welding School in the United States at its corporate headquarters in Cleveland, Ohio. Over 100,000 men and women have graduated from this premier school.

Tuition is affordable and class schedules are flexible to meet your needs. For more information on the Lincoln Welding School, please write to:

Lincoln Welding School

22801 St. Clair Avenue
Cleveland, Ohio 44117-1199

Ask for bulletin ED122

You may reach us at: **216.383.2259**

Classes are in Session from 8:00 AM to 2:30PM

Basic Plate & Sheet Metal

5 Weeks

Plasma, Oxy-fuel, Alloy & Hardfacing

3 Weeks

Pipe — select: • ASME or • API

3 Weeks

Price covers machine beveled pipe nipples used each week.

Prerequisite: Passing Basic Plate & Sheet Metal 5th Week Test

Gas Tungsten Arc Welding (GTAW - TIG)

1 Week

Price covers special alloy, aluminum, gas, etc. used each day.

Gas Shielded Arc Welding (GMAW - MIG) Semi-Automatic

1 Week

Flux Cored Arc Welding (FCAW) Semi-Automatic/Self Shielded/Gas Shielded: 1 Week

• Submerged Arc Welding (SAW) Semi-Automatic/Full- Automatic: 1 Week

• Comprehensive Arc Welder Course

15 Weeks

Includes All Above Courses

**Low Hydrogen Pipe Module:
GMAW/FCAW/SMAW**

1 Week

GTAW/SMAW

1 Week

Qualification Test Training:

**AWS Test Semi-Automatic Flux Cored Arc Welding Self
Shielded (FCAW)**

1 Week

3/8" AWS Fillet Test:

Shielded Metal Arc Welding (SMAW — Stick) ⁽¹⁾

1 Week

AWS Test

Shielded Metal Arc Welding (SMAW - Stick) ⁽¹⁾

1 Week

ASME Test

Shielded Metal Arc Welding (SMAW — Stick) ⁽¹⁾

1 Week

ASME or API Pipe Welding Test Training ⁽¹⁾

1 Week

Low Hydrogen Pipe Welding Test Training ⁽¹⁾

1 Week

Certified Welding Inspector Course ⁽¹⁾

1 Week

⁽¹⁾Actual Testing done in customer's plant or Independent Testing Laboratory

NOTES

NOTES

TEST RESULTS

Test Results for Mechanical Properties, Deposit or Electrode Composition and Diffusible Hydrogen levels were obtained at a single point in time under laboratory conditions from random samples of representative material. Your results may vary within AWS specification limits depending on a variety of conditions.

CUSTOMER ASSISTANCE POLICY

The business of The Lincoln Electric Company is manufacturing and selling high quality welding equipment, consumables, and cutting equipment. Our challenge is to meet the needs of our customers and to exceed their expectations. On occasion, purchasers may ask Lincoln Electric for advice or information about their use of our products. We respond to our customers based on the best information in our possession at that time. Lincoln Electric is not in a position to warrant or guarantee such advice, and assumes no liability, with respect to such information or advice. We expressly disclaim any warranty of any kind, including any warranty of fitness for any customer's particular purpose, with respect to such information or advice. As a matter of practical consideration, we also cannot assume any responsibility for updating or correcting any such information or advice once it has been given, nor does the provision of information or advice create, expand or alter any warranty with respect to the sale of our products.

Lincoln Electric is a responsive manufacturer, but the selection and use of specific products sold by Lincoln Electric is solely within the control of, and remains the sole responsibility of the customer. Many variables beyond the control of Lincoln Electric affect the results obtained in applying these types of fabrication methods and service requirements.

Subject to Change — This information is accurate to the best of our knowledge at the time of printing. Please refer to www.lincolnelectric.com for any updated information.

LINCOLN[®]
ELECTRIC

THE WELDING EXPERTS

THE LINCOLN ELECTRIC COMPANY

22801 Saint Clair Ave.
Cleveland, Ohio 44117-1199

TEL: 216.481.8100 • FAX: 216.486.1751

www.lincolnelectric.com

Cored Wire
C3.2400 2/04